

Spreader and Vehicle Battery Kits

Hopper Spreaders

Parts List and Installation Instructions

⚠ CAUTION

Read this document before installing the spreader and vehicle battery kit.

⚠ CAUTION

Use standard methods and practices when attaching spreader and installing accessories, including proper personal protective safety equipment.

SPREADER AND VEHICLE BATTERY KITS PARTS LIST

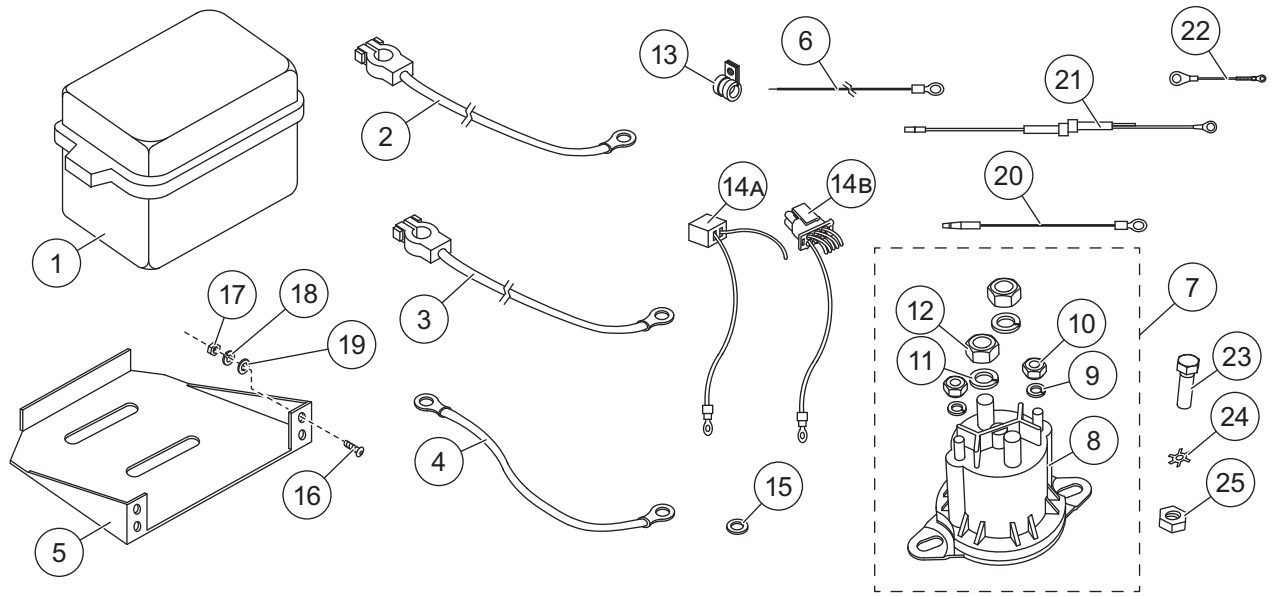

65605-4 Spreader Battery Kit							
Item	Part	Qty	Description	Item	Part	Qty	Description
1	65251	1	Battery Case w/Strap	6	68869	1	Hopper Spreader Ground Wire
2	65246	1	Battery Cable – Red (POS [+])	7	5794K-1/ 56131K-2	1	Motor Relay Kit
3	67239	1	Battery Cable – 53" Black	ns	65990-2	1	Parts Bag
4	22511K	1	Battery Cable – 22" Red				
5	76595	1	Battery Tray				
Item 7 5794K-1 / 56131K-2 Motor Relay Kit							
8		1	Motor Relay	11	91202	2	5/16 Spring Lock Washer
9	91242	2	#10 Spring Lock Washer	12	92842	2	5/16-24 Hex Jam Nut G5
10	91402	2	#10-32 Hex Machine Screw Nut				
65990-2 Parts Bag							
13	65340	2	Clamp Loop #10	18	91123	4	3/8 Flat Washer Type A Wide SS
14A	65380	1	Alternator Wire – Red w/Plug, Tecumseh	19	91282	4	3/8 Spring Lock Washer SS
14B	95584	1	Alternator Wire, 6-Pin, Tecumseh	20	94549	1	Charge Wire, Honda®
15	90980	1	5/16 Flat Washer Type A Narrow	21	96186	1	Charge Wire, Briggs & Stratton
16	90375	4	3/8-16 x 1 Carriage Bolt	22	56155	1	Jumper Wire
17	91431	4	3/8-16 Hex Nut SS	23	90381	2	1/4-20 x 3/4 Hex Cap Screw SS
				24	67083	2	1/4 External Lock Washer SS
				25	91429	2	1/4-20 Hex Nut
ns = not shown			G = Grade			SS = Stainless Steel	

Honda® is a registered trademark of Honda Motor Co.

SPREADER AND VEHICLE BATTERY KITS PARTS LIST

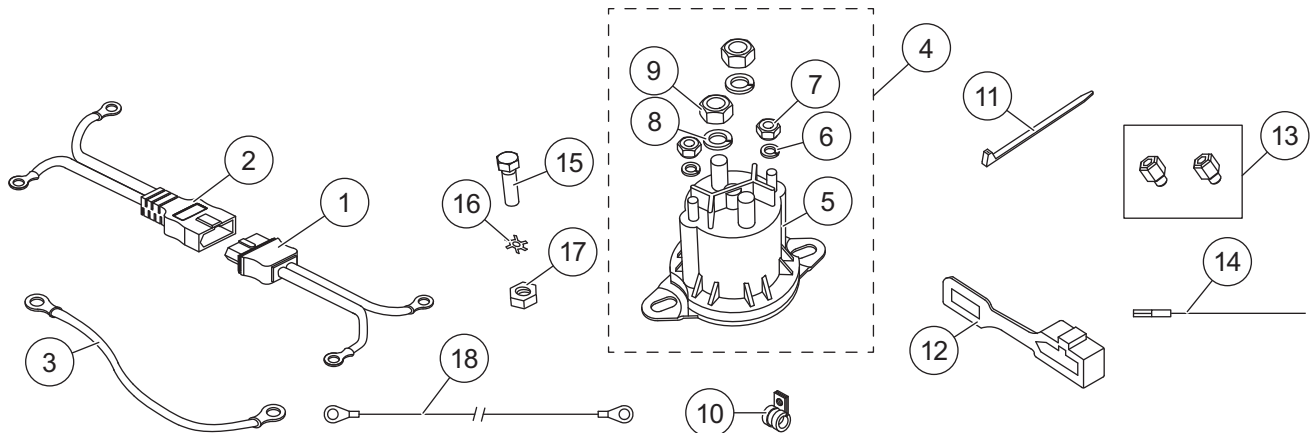

94680 Vehicle Battery Kit							
Item	Part	Qty	Description	Item	Part	Qty	Description
1	66424	1	Battery Cable, Vehicle End	4	5794K-1/ 56131K-2	1	Motor Relay Kit
2	66425	1	Battery Cable, Spreader End	ns	94892	1	Parts Bag
3	22511K	1	Battery Cable – 22" Red				
Item 4				5794K-1/56131K-2 Motor Relay Kit			
5		1	Motor Relay	8	91202	2	5/16 Spring Lock Washer
6	91242	2	#10 Spring Lock Washer	9	92842	2	5/16-24 Hex Jam Nut G5
7	91402	2	#10-32 Hex Machine Screw Nut				
94892 Parts Bag							
10	65340	2	Clamp Loop #10	15	90381	2	1/4-20 x 3/4 Hex Cap Screw SS
11	59223	6	Cable Tie	16	67083	2	1/4 External Lock Washer SS
12	61548K	1	Plug Cover Kit	17	91429	2	1/4-20 Hex Nut
13	22381W/22381K	1	Battery Cable Adapter	18	67241	1	26" Wire, Green
14	67537	1	Relay Wire, Premium Control	ns		1	Convolved Tubing
			ns = not shown				G = Grade
							SS = Stainless Steel

SERIAL # LOCATION AND ID

SERIAL NUMBER LABEL LOCATION AND ID

**1st Generation
Serial # Label
4-Digit Serial #
7664 – Lower**

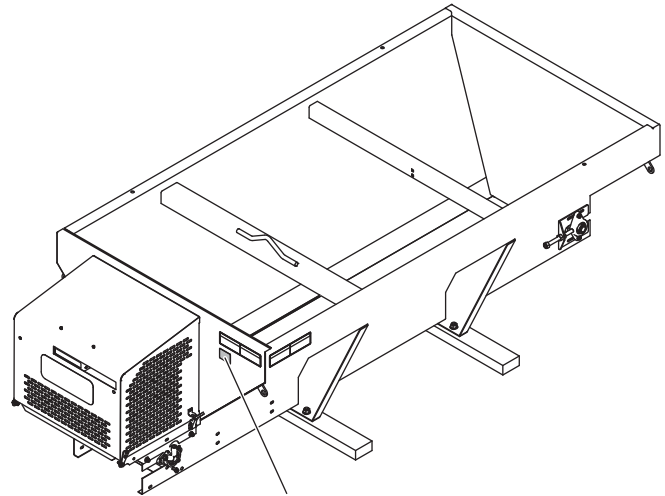
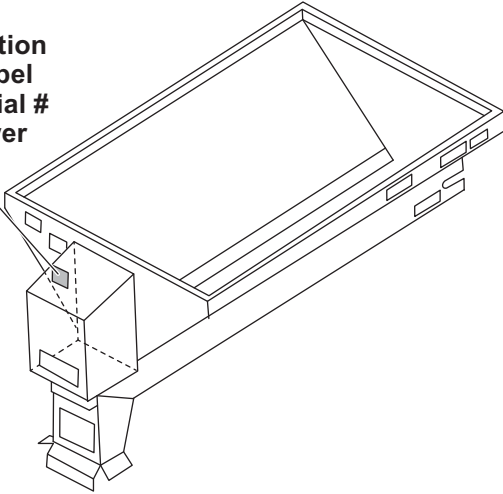

**2nd Generation
Serial # Label
17- or 19-Digit Serial #
Beginning 150513 – Lower
YYMMDDLXXXXZZZZZ**

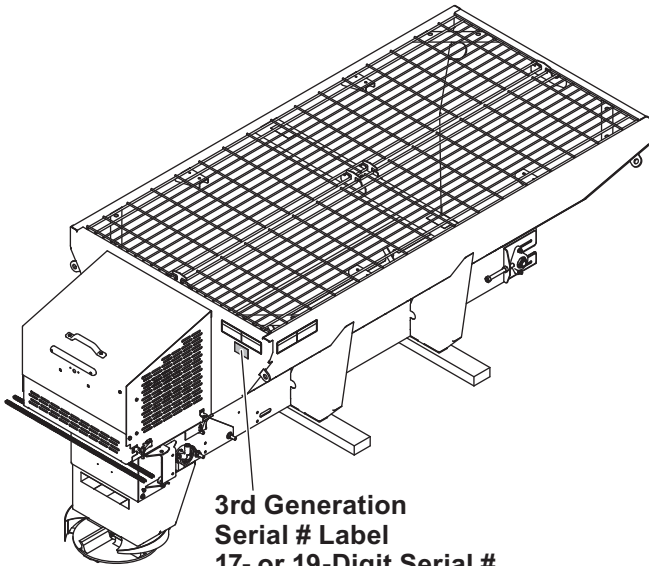

**3rd Generation
Serial # Label
17- or 19-Digit Serial #
Beginning 150514 – Higher
YYMMDDLXXXXZZZZZ**

Code	Definition
YY	2-Digit Year
MM	2-Digit Month
DD	2-Digit Day
LL	2-Digit Location Code
XXXX	4-Digit Sequential Number
ZZZZZ	5- to 7-Digit Assembly PN

SPREADER BATTERY KIT INSTALLATION INSTRUCTIONS

SPREADERBATTERYKITINSTALLATION

NOTE: Apply dielectric grease to all electrical terminals before assembly.

Battery Safety

⚠ CAUTION

Batteries normally produce explosive gases, which can cause personal injury. Therefore, do not allow flames, sparks, or lit tobacco to come near the battery. When charging or working near a battery, always cover your face and protect your eyes, and also provide ventilation.

- Batteries contain sulfuric acid, which burns skin, eyes, and clothing.
- Disconnect the battery before removing or replacing any electrical components.

1. Install the battery tray with the four supplied 3/8" x 1" carriage bolts, flat washers, lock washers, and nuts.
2. Install a 12V battery with a minimum of 400A cold cranking rating. The battery box will accept any group 22-, 24-, 27-, 64-, or 65-series top-terminal battery.

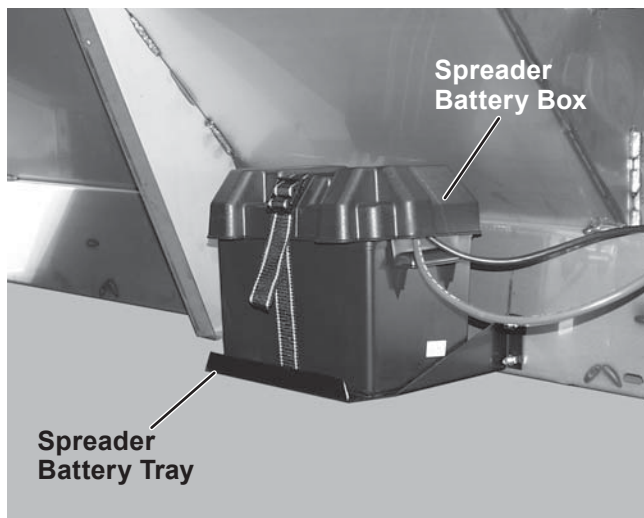

For spreaders made prior to date code 150514 (1st and 2nd generation models – see previous page for model clarification):

1. Mount the starter relay to the engine base using the existing hardware and an additional 1/4" x 3/4" cap screw, external tooth lock washer, and nut. Reconnect the black wire from the clutch and the green wire from the harness. Connect the supplied relay ground wire (red) and the spreader ground wire (green).

NOTE: Starter relay styles may vary.

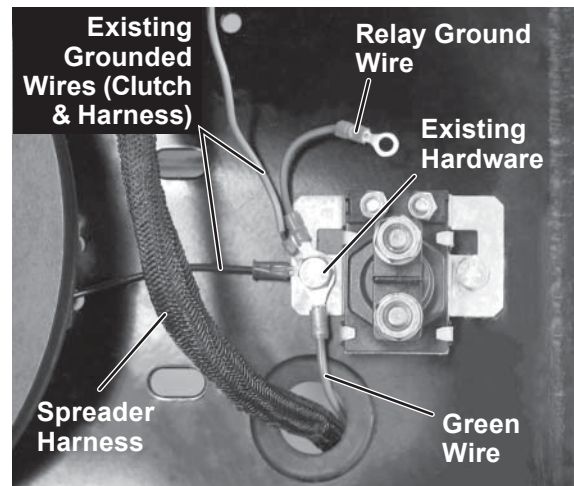

2. Connect the white wire from the spreader harness to one of the primary (small) terminals of the starter relay and connect the relay ground wire to the other small primary terminal on the relay.

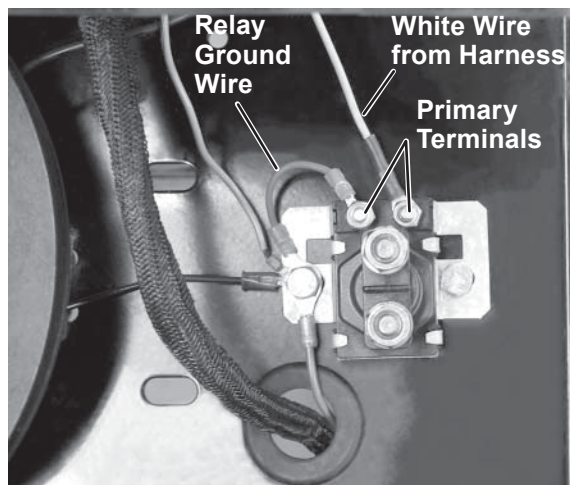

SPREADER BATTERY KIT INSTALLATION INSTRUCTIONS

3. Connect the red starter cable (PN 22511K) from the starter to one of the large secondary terminals on the starter relay.

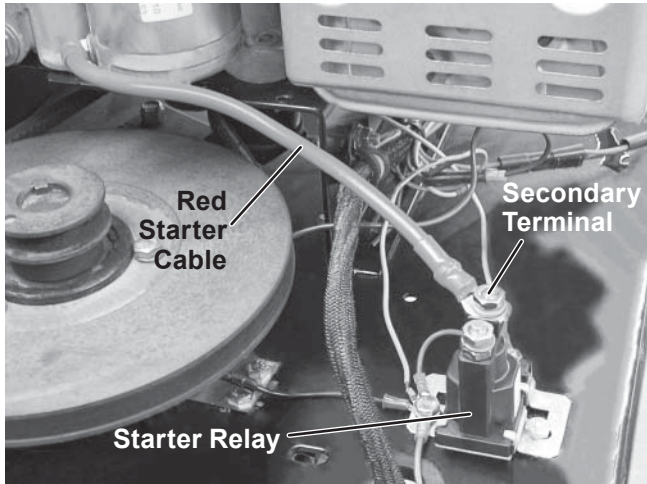

For Honda® and Briggs & Stratton engines, connect the charge wire to the plug on the engine.

For Tecumseh engines, connect the alternator wire with plug to the alternator plug on the engine.

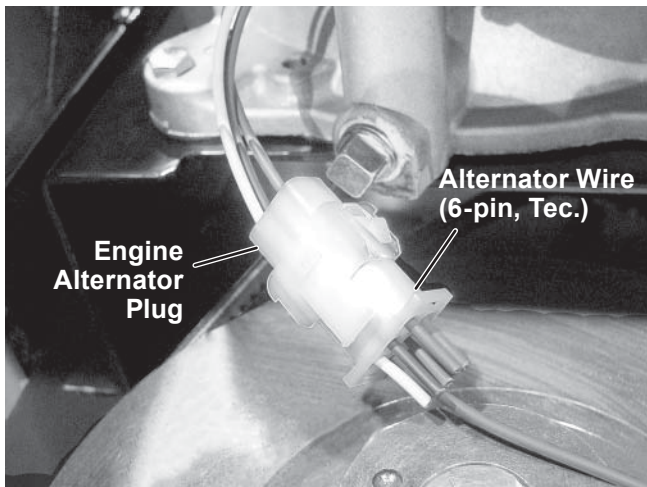

4. Route the battery cables through the rubber grommet in the engine base. Secure with #10 clamp loops.

NOTE: Use the fasteners that secure the spreader harness for securing the spreader cable.

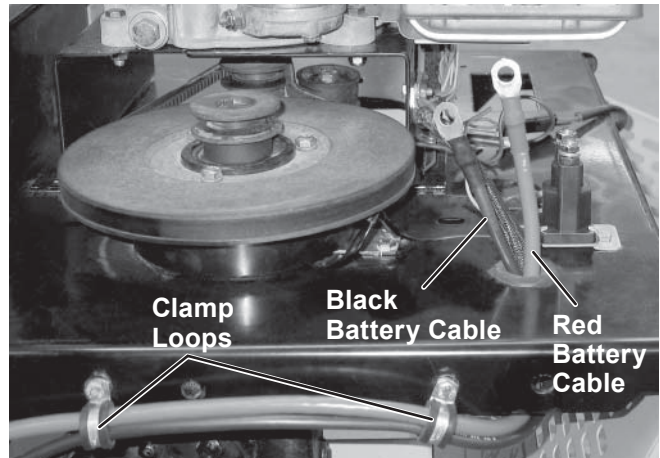

5. Connect the charge wire (Honda and Briggs & Stratton) or alternator wire (Tecumseh) and the red battery cable to the unused secondary terminal of the starter relay.

NOTE: The white alternator wire included with the Tecumseh engine is not used.

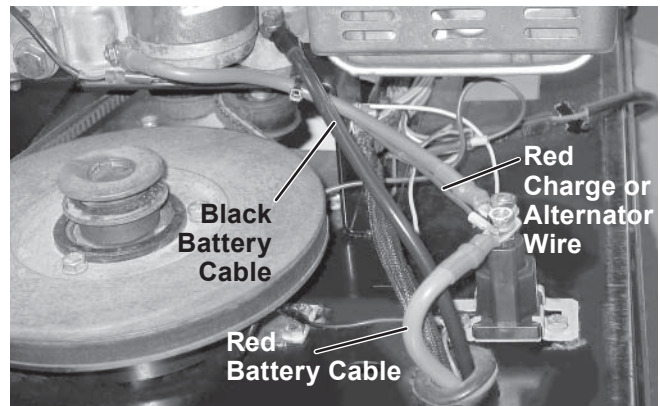

6. Connect the red battery cable (PN 65246) to the POSITIVE (+) terminal of the battery.
7. Attach one end of the black battery cable (PN 67239) to the spreader engine mounting flange using the existing 5/16" cap screw, nut, lock washer, and supplied 5/16" flat washer.
8. Connect the unused end of the black battery cable to the NEGATIVE (-) terminal of the battery.
9. Install the black wire from the spreader harness to the engine shut-off circuit.

Honda® is a registered trademark of Honda Motor Co.

SPREADER BATTERY KIT INSTALLATION INSTRUCTIONS

For spreaders made after date code 150514 (3rd Generation Spreaders – see page 4 for model generation clarification):

⚠ CAUTION

Before drilling holes, check to be sure that no vehicle wiring or other components could be damaged.

NOTE: Starter relay styles may vary. Do NOT use the starter relay on Honda® engines.

1. Locate the starter relay on the passenger's side of the engine base. Using the starter relay mounting flange as a template, drill two 9/32" holes (if holes are not already present) and fasten with two 1/4" x 3/4" cap screws, lock washers, and nuts.

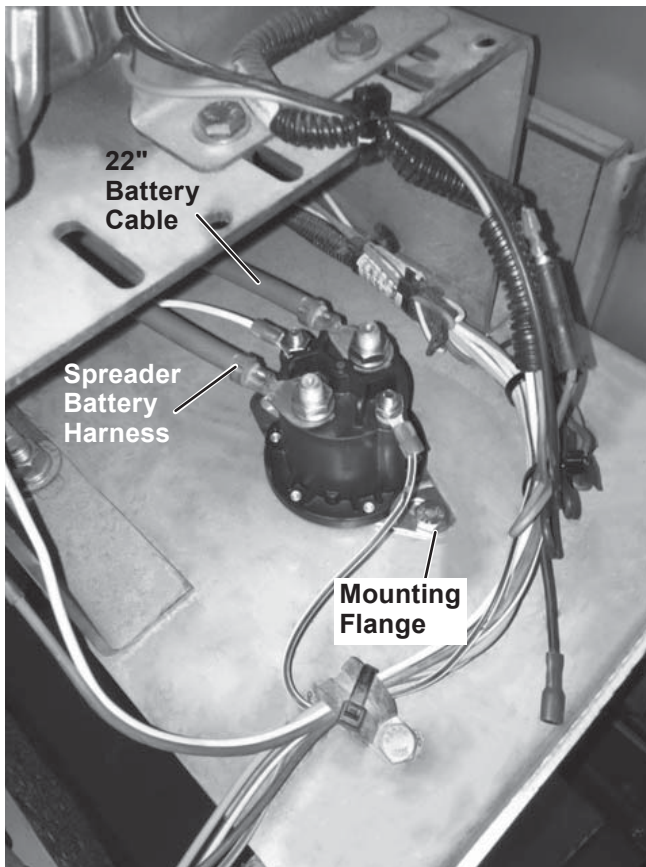

2. Install the red battery cable (PN 66246) to one of the large secondary terminals of the starter relay and to the POSITIVE (+) battery terminal.

For Briggs & Stratton and Honda engines:

Connect the red charge wire to the same secondary terminal as in the previous step.

3. Install the black battery cable to spreader engine mounting flange using the existing 5/16" cap screw, washer, lock washer, and nut and to the NEGATIVE (-) battery terminal.

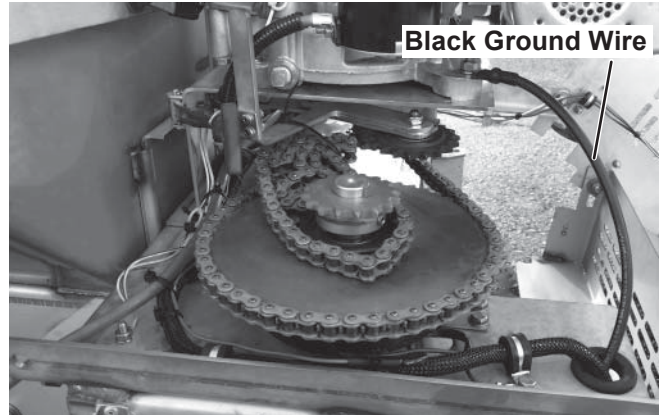

4. Connect the 22" red battery cable to the second large secondary terminal of the starter relay and to the starter motor terminal.

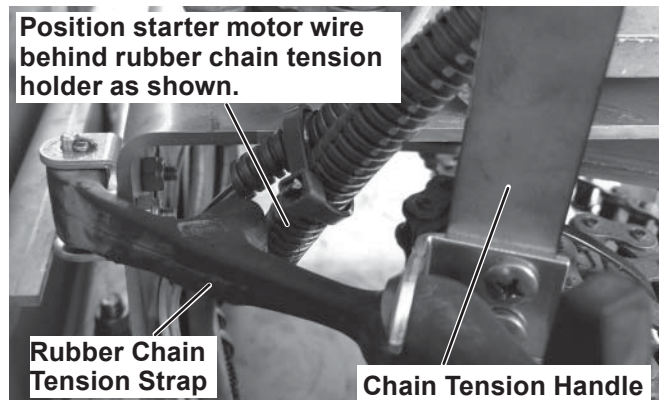
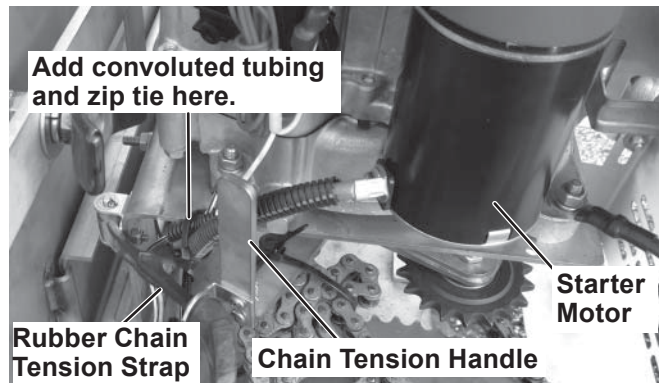

Honda® is a registered trademark of Honda Motor Co.

SPREADER BATTERY KIT INSTALLATION INSTRUCTIONS

5. Connect the white wire from the spreader harness to a small primary terminal of the starter relay.
6. Connect the white/black wire from the spreader harness to the other small primary terminal of the starter relay and to the engine mounting flange using the existing 5/16" cap screw, washer, lock washer, and nut.

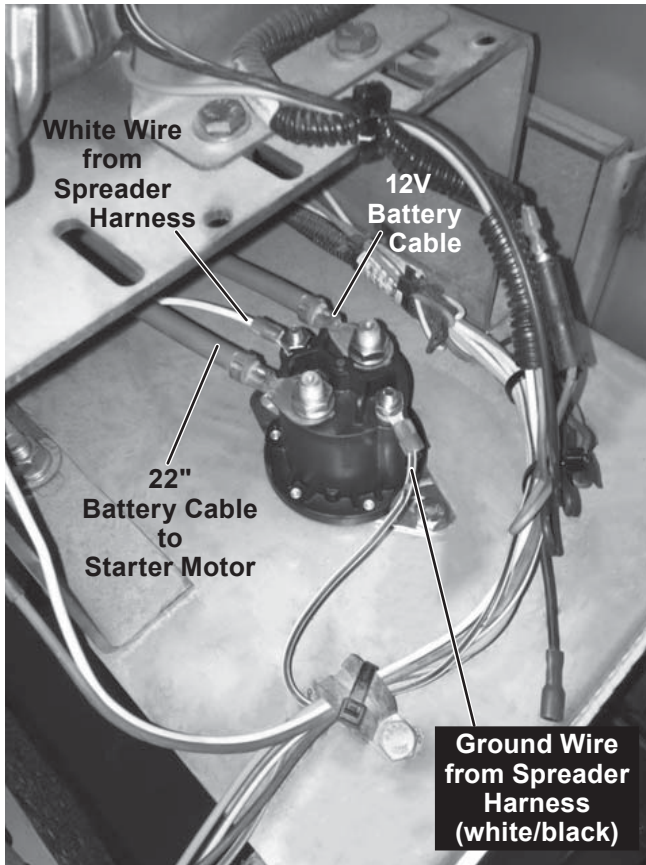

7. Verify that the black wire from the spreader harness to the engine shut-off circuit is connected.

NOTE: Verify that all wires are protected or secured away from sharp edges and hot or moving parts.

NOTE: Honda® engines use a bullet terminal; Briggs & Stratton engines use a spade terminal. See photos.

Honda Engines

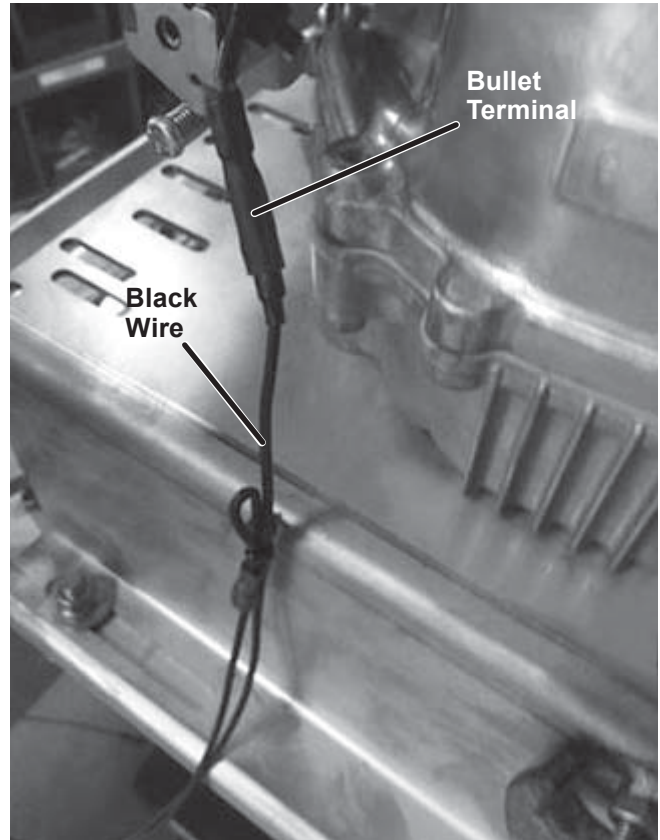

Briggs & Stratton Engines

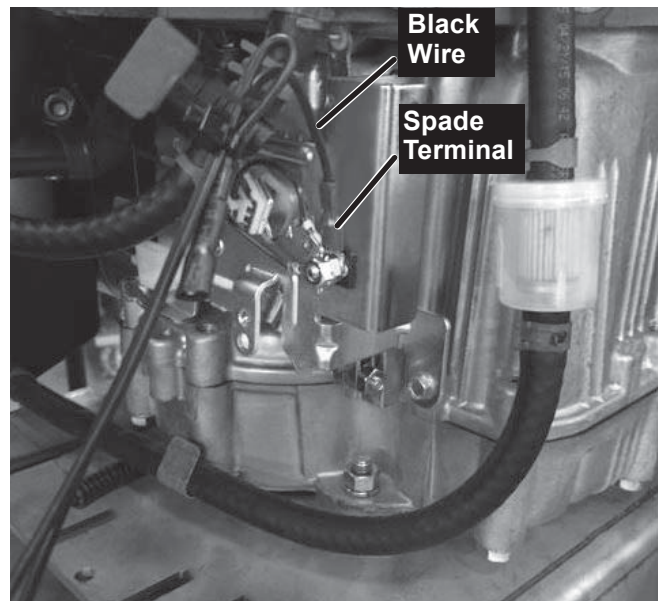

Honda® is a registered trademark of Honda Motor Co.

VEHICLE BATTERY KIT INSTALLATION INSTRUCTIONS

VEHICLE BATTERY KIT INSTALLATION (VEHICLE SIDE)

Battery Safety

⚠ CAUTION

Batteries normally produce explosive gases, which can cause personal injury. Therefore, do not allow flames, sparks, or lit tobacco to come near the battery. When charging or working near a battery, always cover your face and protect your eyes, and also provide ventilation.

- Batteries contain sulfuric acid, which burns skin, eyes, and clothing.
- Disconnect the battery before removing or replacing any electrical components.

NOTE: Apply dielectric grease to all electrical terminals before assembly.

Battery

1. Verify that vehicle battery is in good condition.
2. Disconnect the ground cable from the battery.

Starter Relay

NOTE: Starter relay styles may vary.

1. Locate an area protected from road splash and within 18" of the vehicle's primary battery. Verify that the 22" red battery cable (PN 22511K) is long enough to connect the battery to the relay. **DO NOT INSTALL THE CABLE AT THIS TIME.**

⚠ CAUTION

Before drilling holes, check to be sure that no vehicle wiring or other components could be damaged.

2. Using the starter relay mounting flange as a template, drill two 9/32" holes, and fasten with two 1/4" x 3/4" cap screws, lock washers, and nuts.

Battery Cable

1. Install the 22" red battery cable (PN 22511K) to one of the large secondary terminals of the starter relay and the POSITIVE (+) battery terminal. Use the supplied side-post battery adapter if necessary. Attach the battery adapter (PN 22381) to the battery, and tighten the adapter to 124–178 in-lb. Attach the OEM battery cable to the adapter with the OEM fastener. Hold the battery adapter with a wrench while tightening the OEM fastener to 124–178 in-lb.

NOTE: A battery cable adapter kit (PN 22381) is provided for side-terminal batteries.

2. Verify that the cable is protected or secured away from all sharp edges and hot or moving parts.

Relay Wire

1. Install and secure the white relay wire (PN 67537) between the cab control and a small primary terminal of the starter relay. See cab control diagram supplied with the control for connection of the white wire to the start switch.
2. Install the supplied 26" green ground wire (PN 67241) to the other of the small primary terminals of the starter relay and the NEGATIVE (–) battery terminal. (Use PN 22381 side terminal battery adapters, if applicable.)

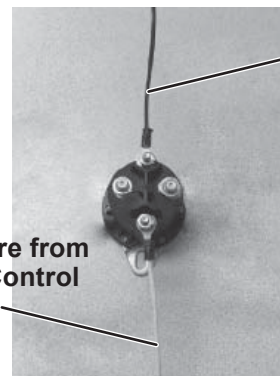

3. Verify that the wire is protected or secured away from all sharp edges and hot or moving parts
4. Begin routing the vehicle battery cable from the engine compartment along the vehicle frame to the rear bumper.
5. Secure the vehicle cable to the vehicle, avoiding sharp edges and hot or moving parts.

VEHICLE BATTERY KIT INSTALLATION INSTRUCTIONS

6. Verify that the vehicle cable cannot drop onto the road when it is disconnected from the spreader.
7. Allow 8"-12" from the end of the vehicle battery cable plug to the rear of the bumper. Any additional cable should be secured behind the vehicle's bumper.
8. Connect the solid black wire of the vehicle cable (PN 66424) to the NEGATIVE (-) battery terminal. Use the supplied side-post battery adapter if necessary. Attach the battery adapter to the battery, and tighten the adapter to 124-178 in-lb.
9. Connect the red wire to the unused secondary terminal of the starter relay.

10. Reconnect the ground cable to the battery or battery adapter using the OEM fastener. If using an adapter, hold the battery adapter with a wrench while tightening the OEM fastener to 124-178 in-lb.

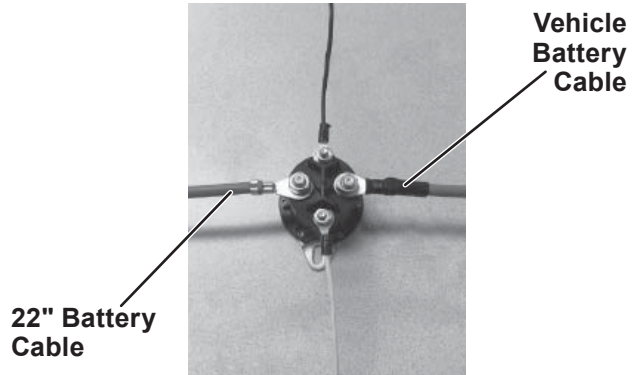

11. Connect the spreader cable (PN 66425) to the vehicle cable (PN 66242).

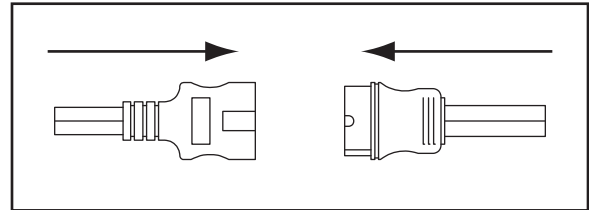

VEHICLE BATTERY KIT INSTALLATION INSTRUCTIONS

Spreader Cable

1. At the rear of the spreader, feed the spreader cable (PN 66245) up through the 1" grommet in the engine base used by the spreader harness.
2. Attach the solid black wire of the spreader cable to the engine flange using the existing 5/16" cap screw, nut, lock washer, and supplied 5/16" flat washer.

3. Connect the red wire of the spreader cable to the starter motor terminal.
4. Route the spreader cable per the images of the model below and secure. The 1st and 2nd generation spreaders will be secured using the clamp loops; 3rd generation spreaders will be secured using zip ties.

NOTE: Use the fasteners that secure the spreader harness for securing the spreader cable.

For 1st and 2nd generation spreaders:

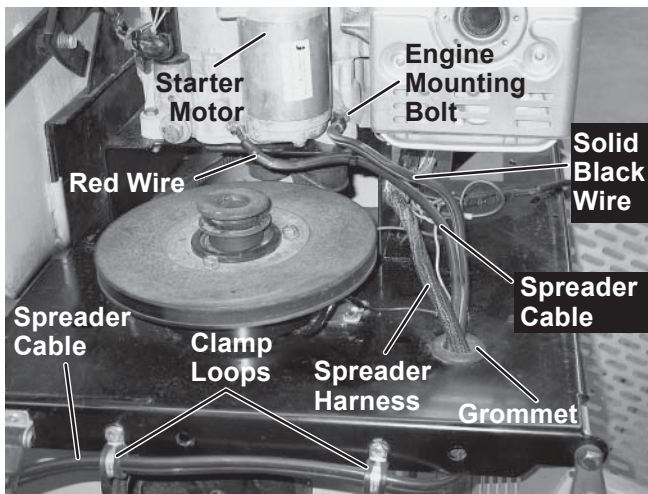

For 3rd generation spreaders:

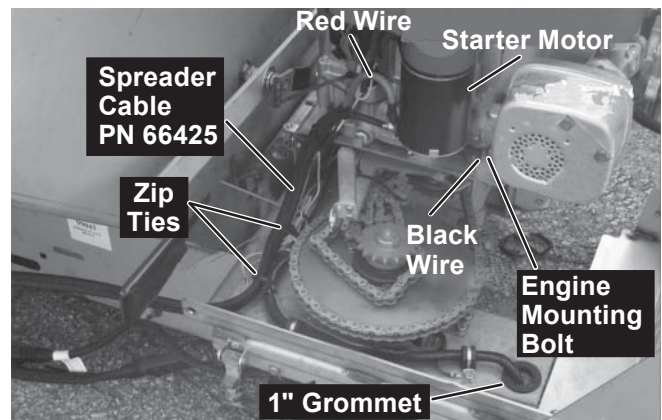

1ST & 2ND GENERATION WIRING DETAILS

HOPPER SPREADER WIRING DIAGRAM - VEHICLE BATTERY KIT

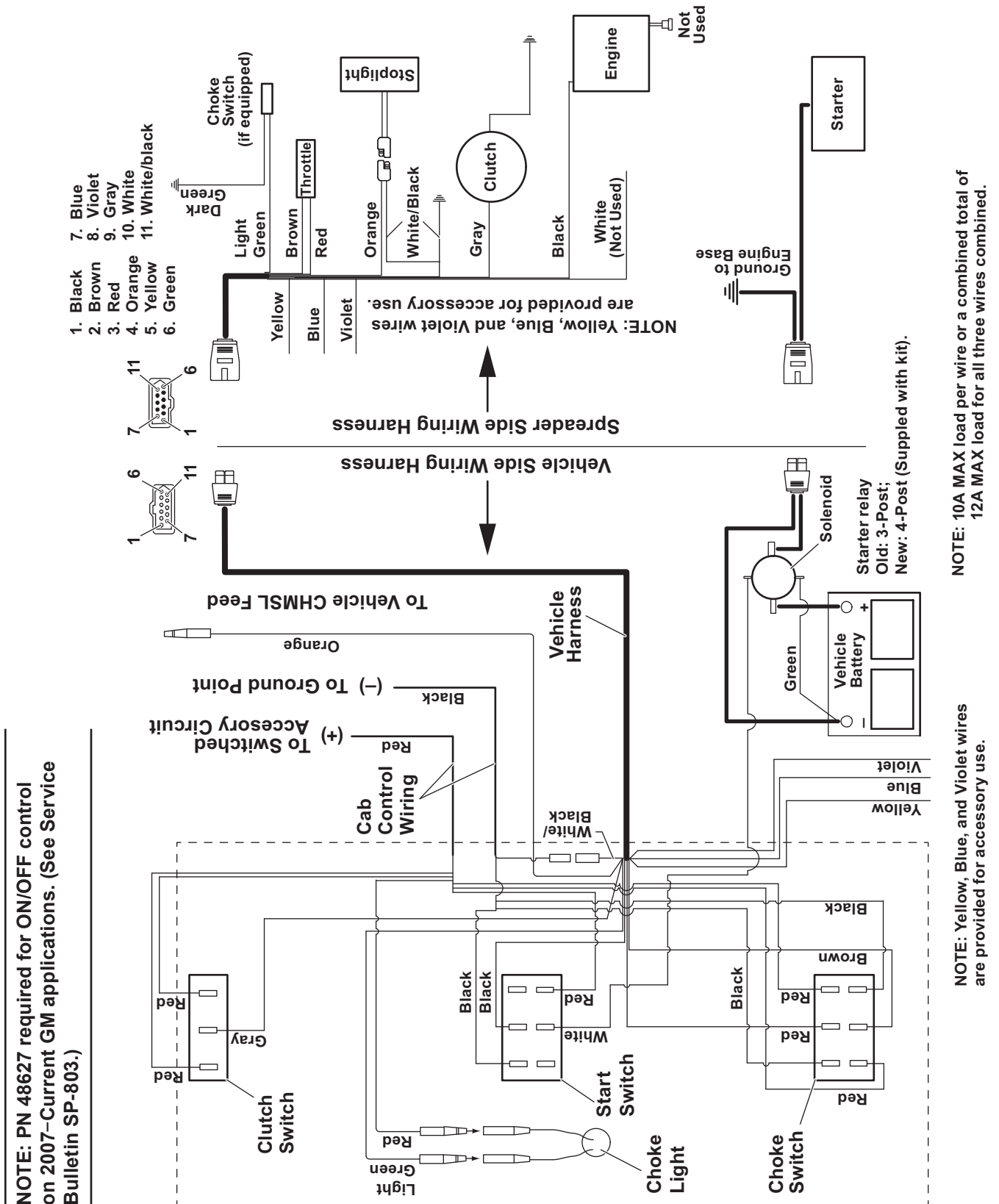

1ST & 2ND GENERATION WIRING DETAILS

HOPPER SPREADER WIRING DIAGRAM – SPREADER BATTERY KIT

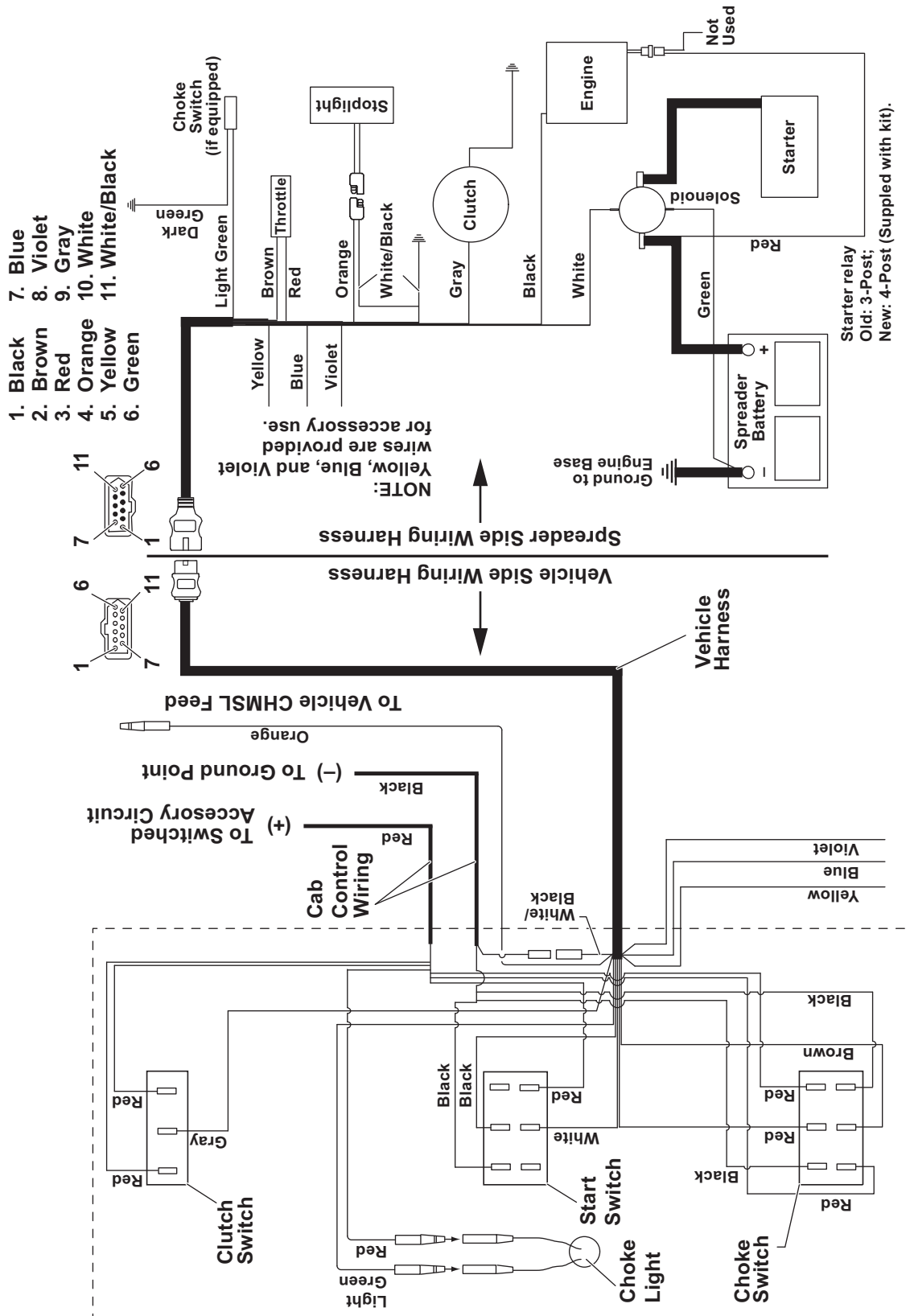

NOTE: 10A MAX load per wire or a combined total of 12A MAX load for all three wires combined.

NOTE: Yellow, Blue, and Violet wires are provided for accessory use.

3RD GENERATION WIRING DETAILS (SPREADER BATTERY KIT)

Honda® ELECTRIC START WITH SPREADER BATTERY

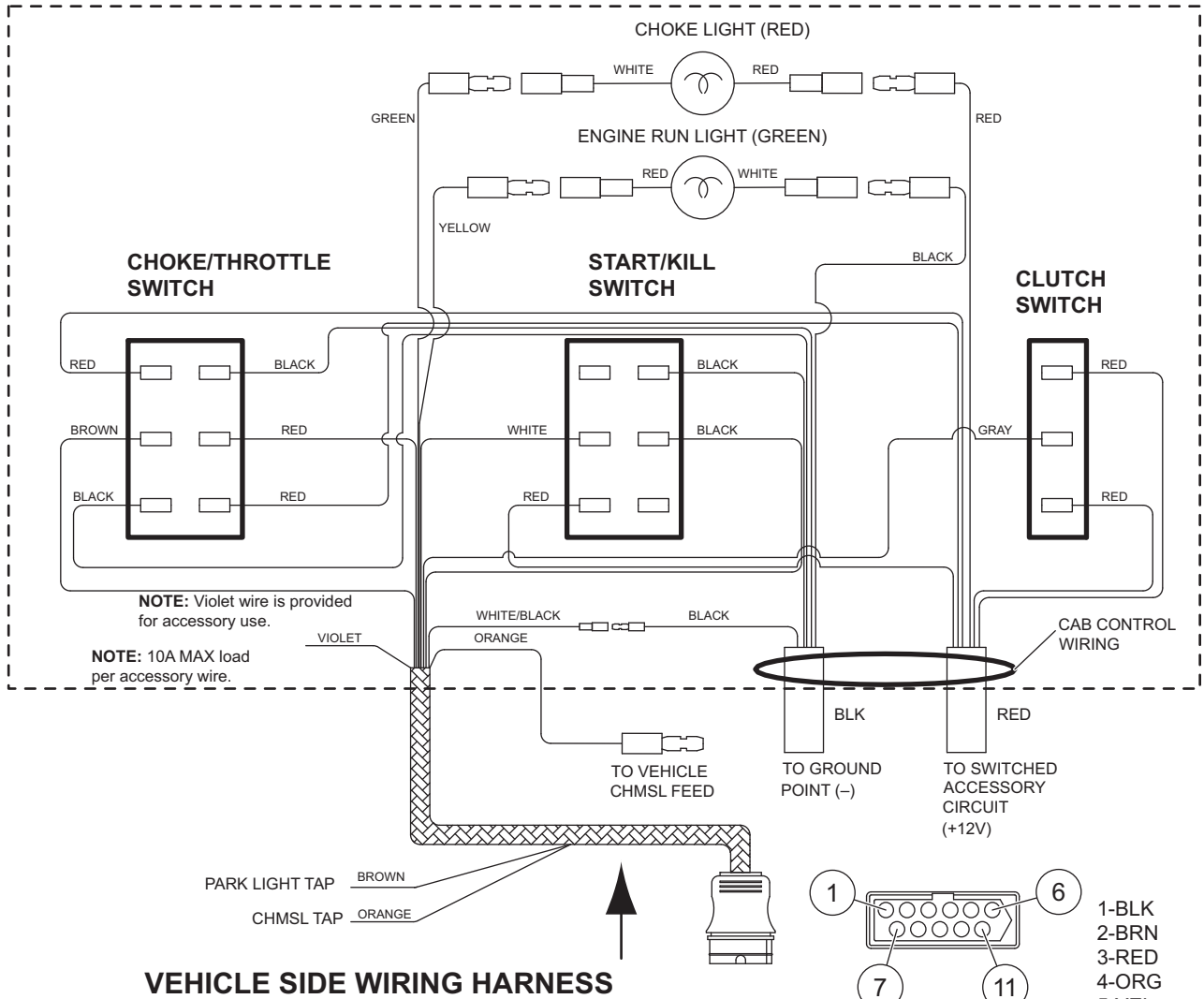

SPREADER SIDE WIRING HARNESS

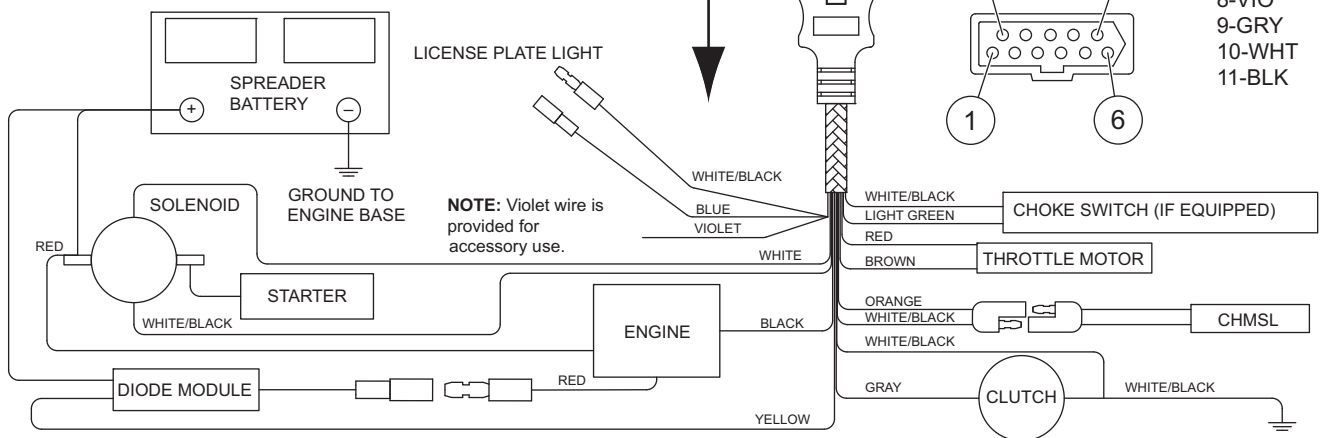

Honda® is a registered trademark of Honda Motor Co.

3RD GENERATION WIRING DETAILS (VEHICLE BATTERY KIT)

Honda® ELECTRIC START WITH VEHICLE BATTERY

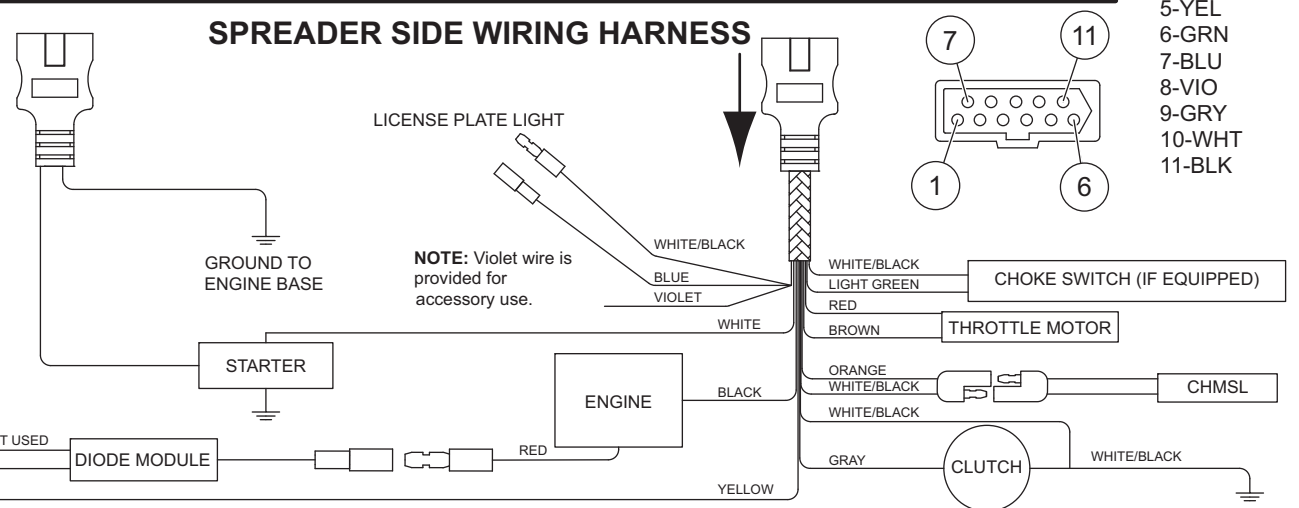
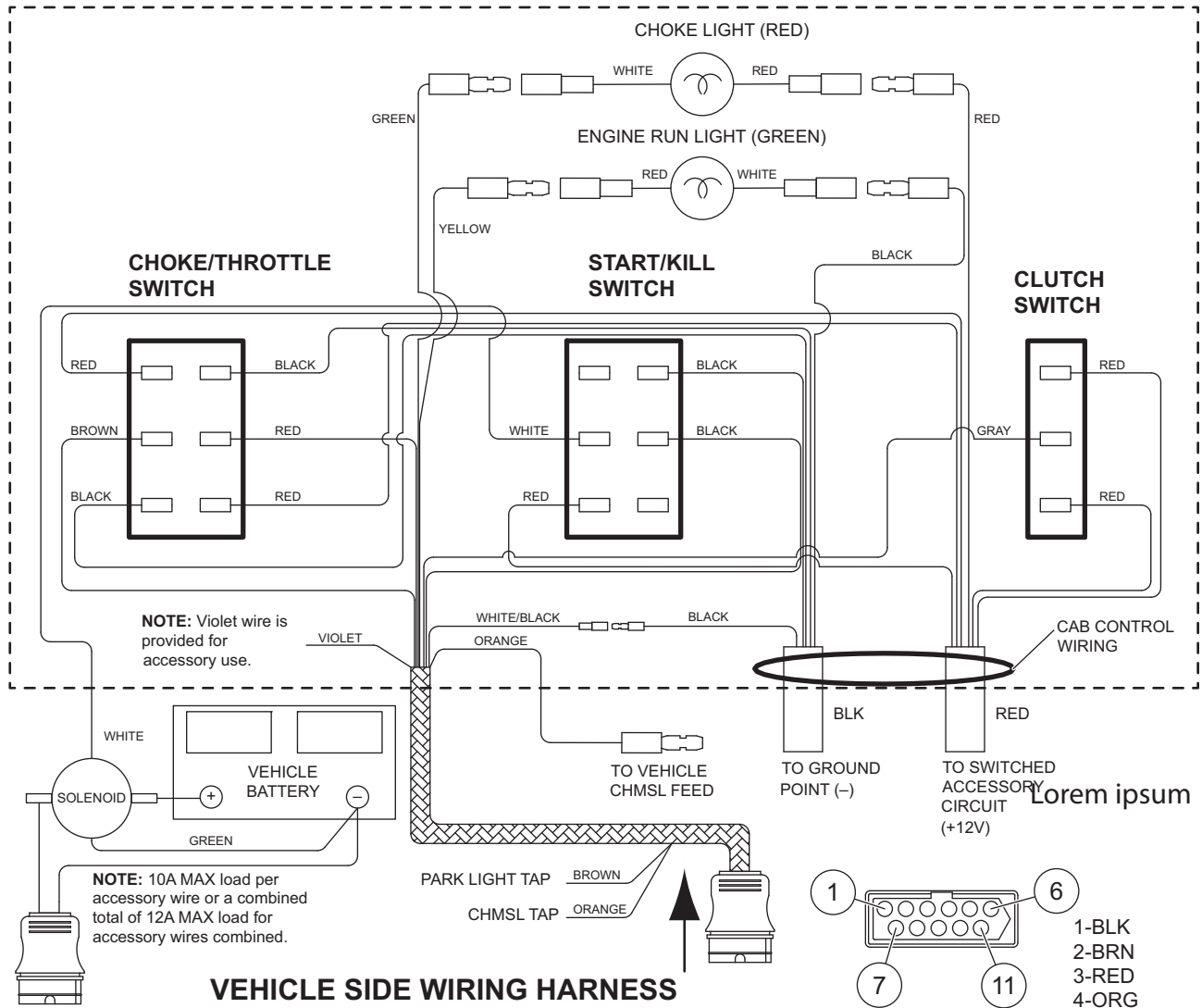

- | | |
|---|----|
| 1 | 6 |
| 7 | 11 |
- 1-BLK
 - 2-BRN
 - 3-RED
 - 4-ORG
 - 5-YEL
 - 6-GRN
 - 7-BLU
 - 8-VIO
 - 9-GRY
 - 10-WHT
 - 11-BLK

Honda® is a registered trademark of Honda Motor Co.

WIRING DIAGRAM (SPREADER BATTERY KIT)

BRIGGS & STRATTON ELECTRIC START WITH SPREADER BATTERY

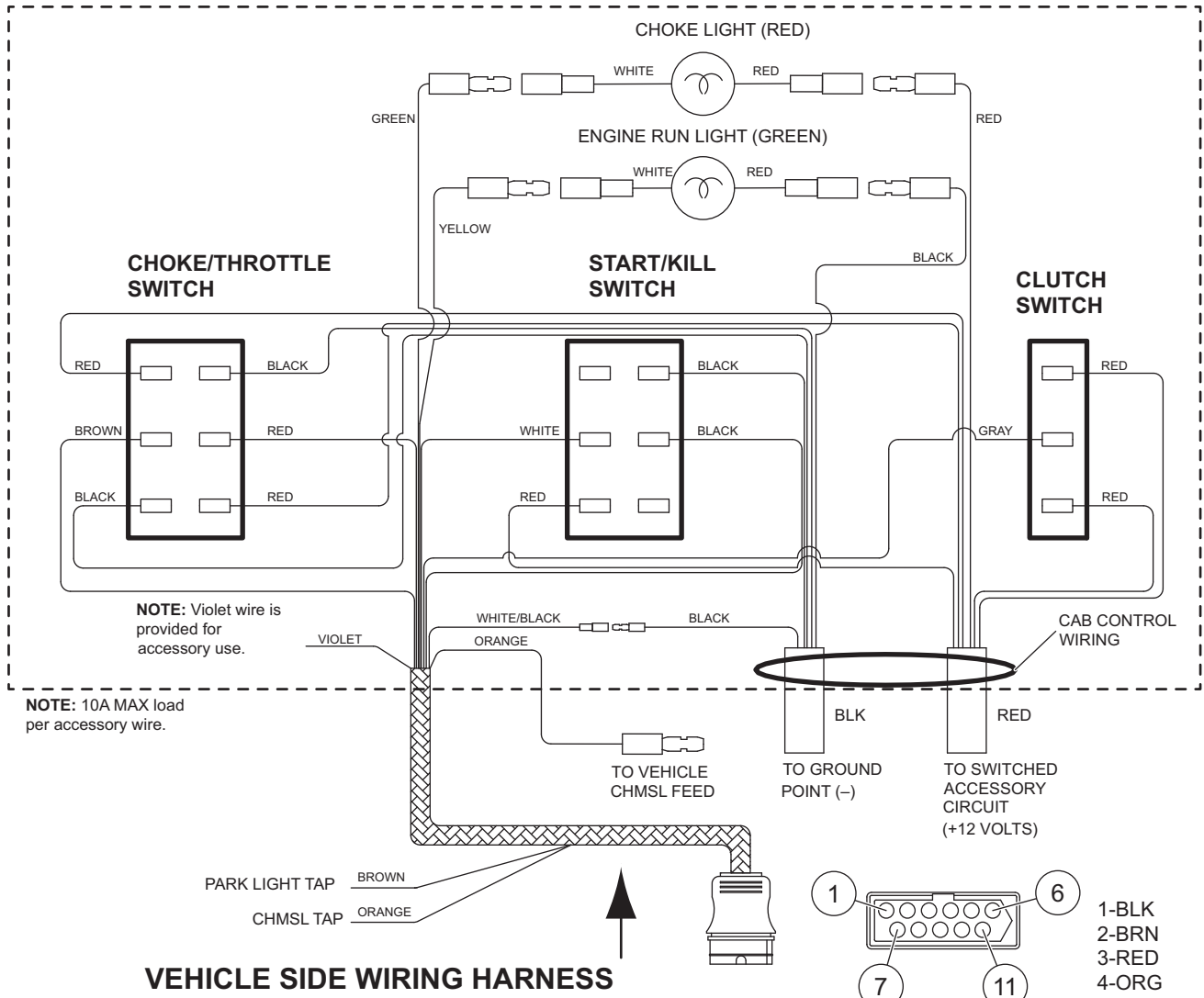

SPREADER SIDE WIRING HARNESS

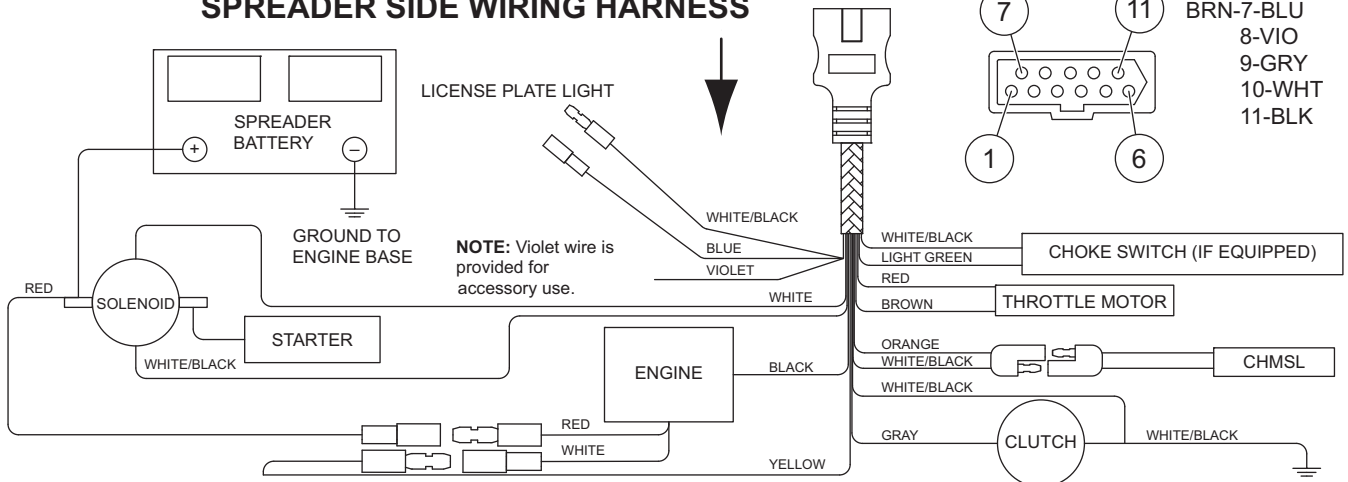

WIRING DIAGRAM (VEHICLE BATTERY KIT)

BRIGGS & STRATTON ELECTRIC START WITH VEHICLE BATTERY

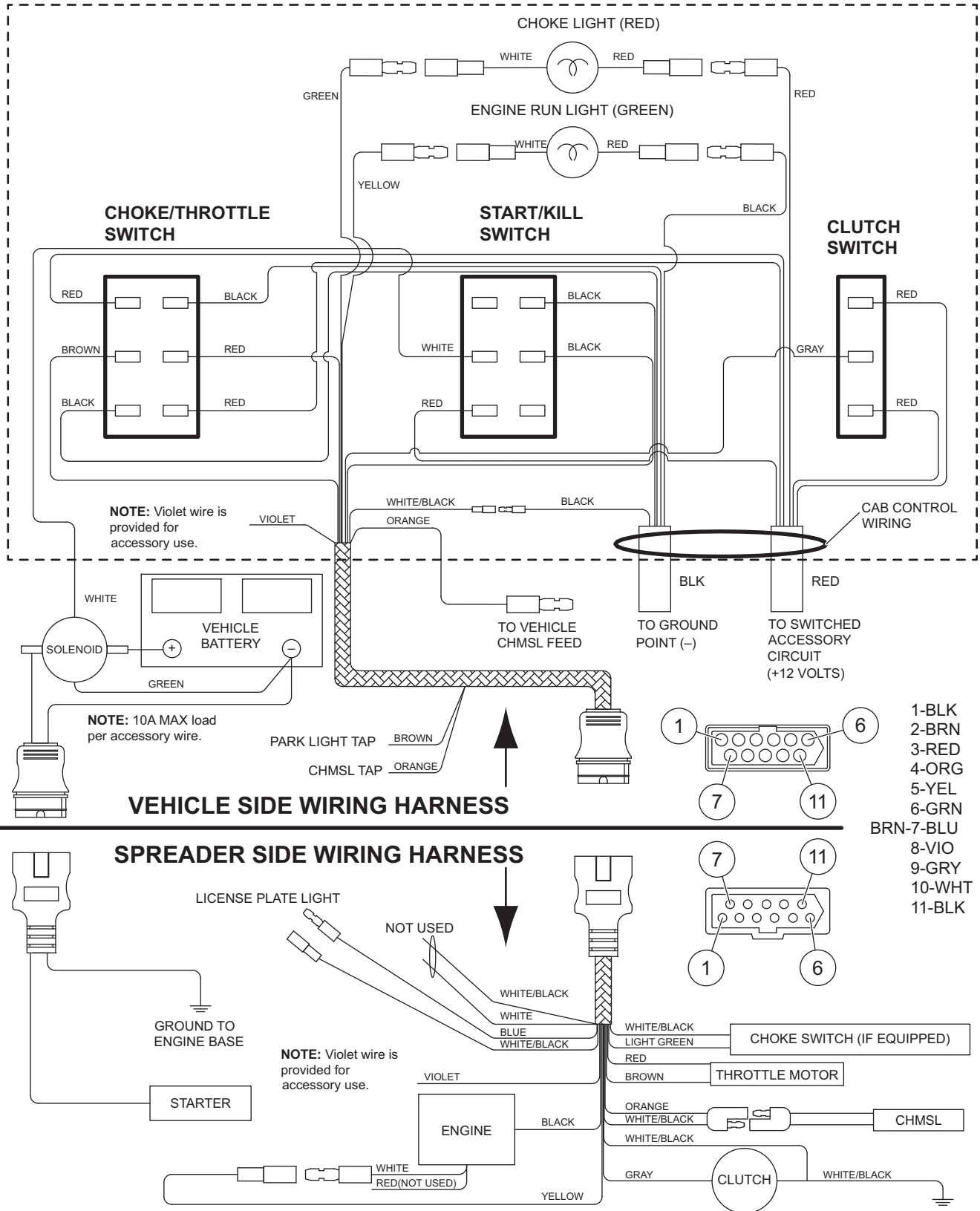

Copyright © 2019 Douglas Dynamics, LLC. All rights reserved. This material may not be reproduced or copied, in whole or in part, in any printed, mechanical, electronic, film, or other distribution and storage media, without the written consent of the company. Authorization to photocopy items for internal or personal use by the company's outlets or spreader owner is granted.

The company reserves the right under its product improvement policy to change construction or design details and furnish equipment when so altered without reference to illustrations or specifications used. This equipment manufacturer or the vehicle manufacturer may require or recommend optional equipment for spreaders. Do not exceed vehicle ratings with a spreader. The company offers a limited warranty for all spreaders. See separately printed page for this important information.

Printed in U.S.A.